

Service Manual

**CIRCUIT DESCRIPTIONS
REPAIR & ADJUSTMENTS**



**ORDER NO.
ARP-086-0**

STEREO TUNER

TX-530L

- This service manual is applicable to the HE, HB types.
- Ce manuel d'instruction se réfère au mode de réglage, en français.
- Este manual de servicio trata del método de ajuste escrito en español.

MODEL TX-530L COMES IN TWO VERSIONS DISTINGUISHED REMARKS AS FOLLOWS:

Type	Voltage	Remarks
HE	220V and 240V	Europe model
HB	220V and 240V	U.K. model

CONTENTS

1. SPECIFICATIONS	2	8. SCHEMATIC DIAGRAM	9
2. FRONT PANEL FACILITIES	3	9. ELECTRICAL PARTS LIST	11
3. PARTS LOCATION	4	10. EXPLODED VIEW	13
4. BLOCK DIAGRAM	5	11. PACKING	14
5. CIRCUIT DESCRIPTIONS	5	12. ADJUSTMENTS	15
6. DIAL CORD STRINGING	6	RÉGLAGE	17
7. P.C. BOARDS CONNECTION DIAGRAM	7	AJUSTE	19

CHANGE OF LINE VOLTAGE

When switching over from 220V to 240V, change the connection of the lead wire for the power transformer.

1. SPECIFICATIONS

FM Tuner Section

Usable Sensitivity	10.8 dBf (1.9 μ V)
50 dB Quieting Sensitivity	Mono; 17.3 dBf (4.0 μ V)
	Stereo; 39.2 dBf (50 μ V)
Sensitivity (DIN)	Mono; 0.85 μ V
	Stereo; 39.8 μ V
Signal-to-Noise Ratio (at 80 dBf)	Mono; 75 dB
	Stereo; 70 dB
Signal-to-Noise Ratio (DIN)	Mono; 74 dB
	Stereo; 66 dB
Distortion (at 60 dBf)	
Stereo	1 kHz; 0.2%
Distortion (DIN)	
Stereo	1 kHz, 0.2%
Capture Ratio	1.0 dB
Alternate Channel Selectivity	60 dB
Stereo Separation	1 kHz; 40 dB
Frequency Response	30 Hz to 15 kHz: $\frac{0.2}{1.0}$ dB
Spurious Response Ratio	70 dB
Image Response Ratio	55 dB
IF Response Ratio	80 dB
AM Suppression Ratio	50 dB
Muting Threshold	19.2 dBf (5 μ V)
Antenna Input	300 ohms balanced, 75 ohms unbalanced

LW Tuner Section

Sensitivity	
IHF, external antenna	45 μ V
Selectivity	25 dB
Signal-to-Noise Ratio	50 dB
Image Response Ratio	40 dB
IF Response Ratio	70 dB
Antenna	Accessory AM loop antenna

MW Tuner Section

Sensitivity	
IHF, external antenna	30 μ V
Selectivity	25 dB
Signal-to-Noise Ratio	50 dB
Image Response Ratio	40 dB
IF Response Ratio	70 dB
Antenna	Accessory AM loop antenna

Audio Section

FM (100% MOD)	650 mV/3.5 k Ω
AM (30% MOD)	200 mV/3.5 k Ω

Miscellaneous

Power Requirements	AC 220 V, 50, 60 Hz
Power Consumption	9.5 W
Dimensions	421 (W) x 69.5 (H) x 226 (D) mm
	16-1/2 (W) x 2-3/4 (H) x 8-7/8 (D) in
Weight (without package)	2.4 kg (5 lb 5 oz)

Furnished Parts

FM T-type Antenna	1
AM Antenna	1
Antenna Catcher	1
Connection Cord with Pin Plugs	1
Operating Instructions	1

NOTE:

Specifications and design subject to possible modification without notice.

2. FRONT PANEL FACILITIES

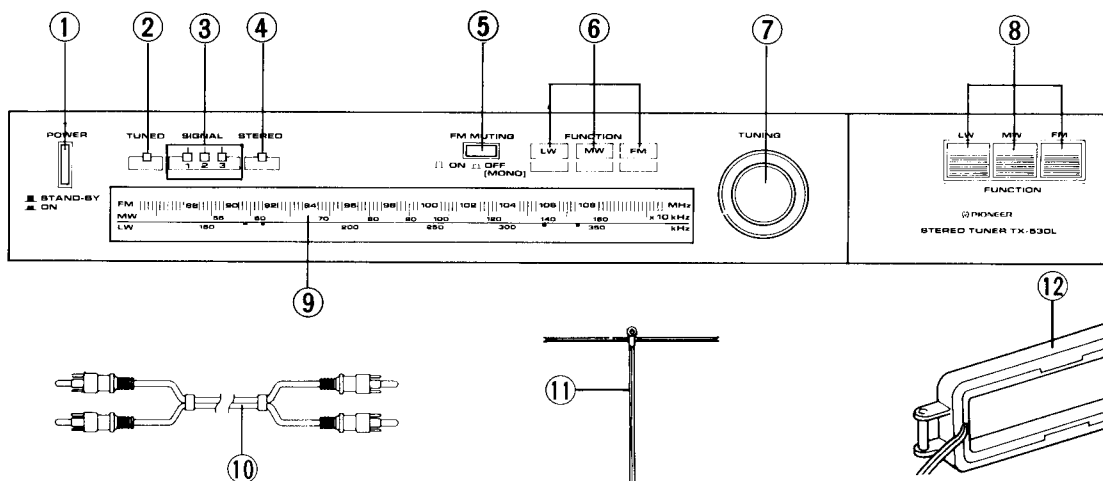

① POWER SWITCH (POWER)

When this switch is set to the ON position, power is supplied to the tuner's main circuits. The unit's power switch is geared to selecting the transformer's secondary and so even at the STAND-BY position, the unit's circuitry will work as long as the power cord is connected to the power outlet. Disconnect the power cord from the AC power outlet when the unit is not in regular use.

② TUNED INDICATOR (TUNED)

This indicates that an FM broadcast station is being received.

The indicator does not light during MW or LW reception.

③ SIGNAL INDICATOR (SIGNAL 1~3)

This indicates the strength of the signals being transmitted by the broadcasting station (FM, MW or LW) which has been tuned in. The higher the lamp which lights, the stronger the signals picked up (and the better the reception).

④ STEREO INDICATOR (STEREO)

This lights automatically when an FM program is being broadcast in stereo.

It does not light when the FM MUTING switch has been set to the OFF/MONO position.

⑤ FM MUTING SWITCH (FM MUTING)

In the released position when it is normally set, this switch suppresses the annoying interstation noise which is heard when tuning in FM broadcasting stations.

If the station signals are weak and there is a great deal of noise and distortion, depress this switch (and monaural sound reproduction results).

This switch does not work with MW and LW reception.

⑥ FM/MW/LW INDICATORS

These indicate the band (FM, MW or LW) on which the signals from the broadcasting station are being received.

⑦ TUNING KNOB

Rotate this knob to pick up the stations (FM, MW or LW).

⑧ FUNCTION SWITCHES (FM, MW or LW)

Depress the FM switch for listening to FM broadcasts. Depress the MW switch for listening to MW broadcasts. Depress the LW switch for listening to LW broadcasts.

⑨ FREQUENCY SCALE

This indicates the frequency of the broadcast station (FM, MW and LW).

The top level figures (88~108) indicate the FM frequencies. The center level figures (55~160) indicate the MW frequencies.

The bottom level figures (150~350) indicate the LW frequencies.

⑩ OUTPUT CORD (accessory)

This is used to hook the unit up with the stereo amplifier.

⑪ T-TYPE FM ANTENNA (accessory)

This antenna is for listening to FM stations and it should be connected to the rear panel of the unit.

This is a spare antenna for listening to FM stations and is used until an outdoor FM antenna is erected. For the best reception, an outdoor antenna should be obtained.

⑫ AM ANTENNA AND ANTENNA CATCHER (accessory)

This antenna is for listening to MW and LW stations and it should be connected to the rear panel of the unit. The antenna catcher is used when fixing the antenna to a wall or other location.

NOTE:

Even with the accessory T-type FM antenna and AM antenna it may be impossible to tune into some stations when the broadcast stations are too far away or when the unit is located in a weak-signal area such as in the mountains. In cases like this, use an external antenna.

3. PARTS LOCATION

NOTES:

- *Parts without part number cannot be supplied.*
- *The ⚠ mark found on some component parts indicates the importance of the safety factor of the part. Therefore, when replacing, be sure to use parts of identical designation.*
- *For your Parts Stock Control, the fast moving items are indicated with the marks ★★ and ★.*
★★ *GENERALLY MOVES FASTER THAN ★.*
This classification shall be adjusted by each distributor because it depends on model number, temperature, humidity, etc.

■ **Front Panel View**

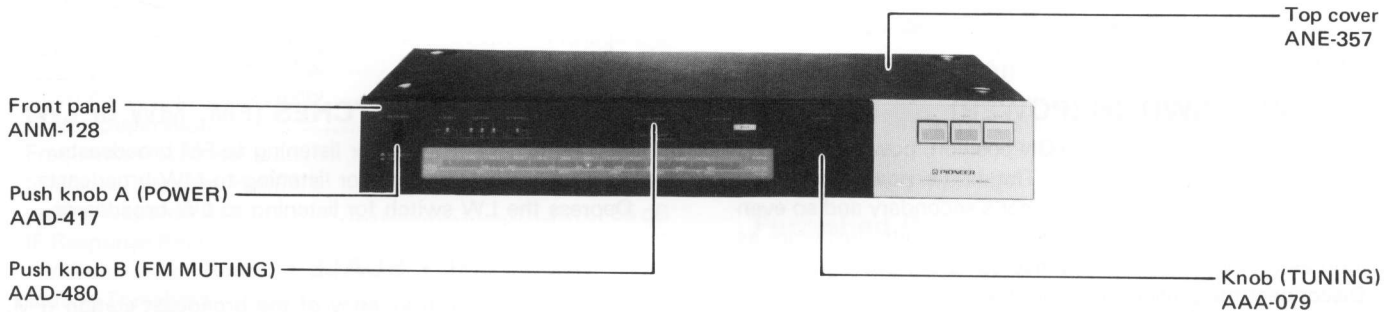

■ **Front View with Panel Removed**

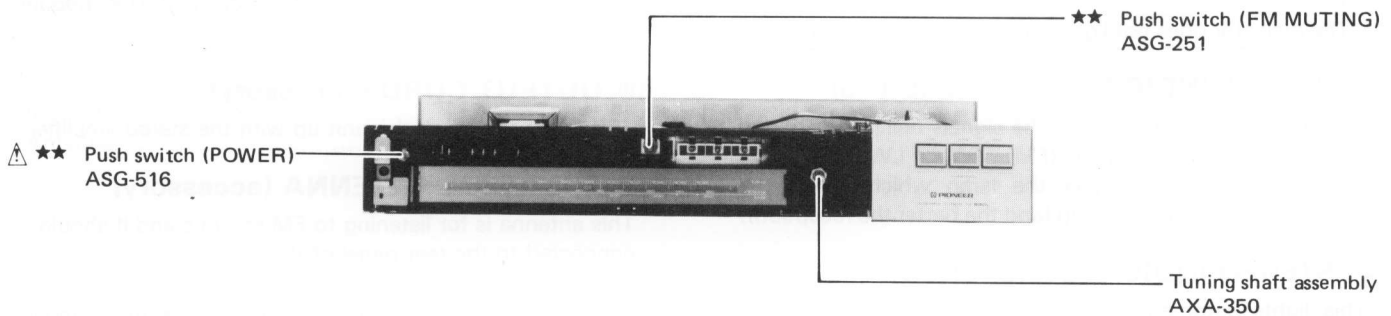

■ **Top View**

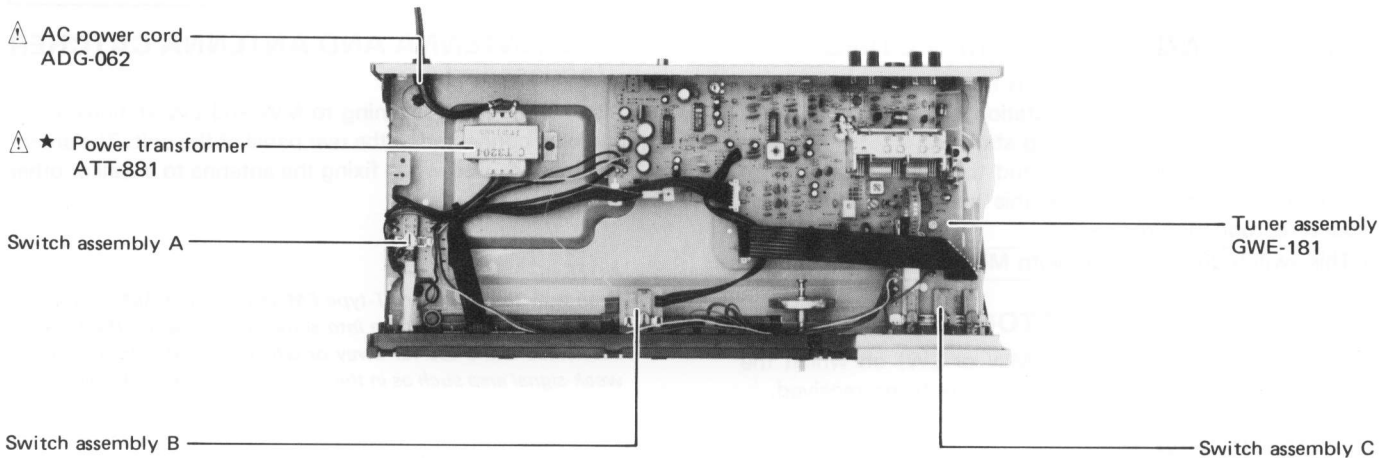

4. BLOCK DIAGRAM

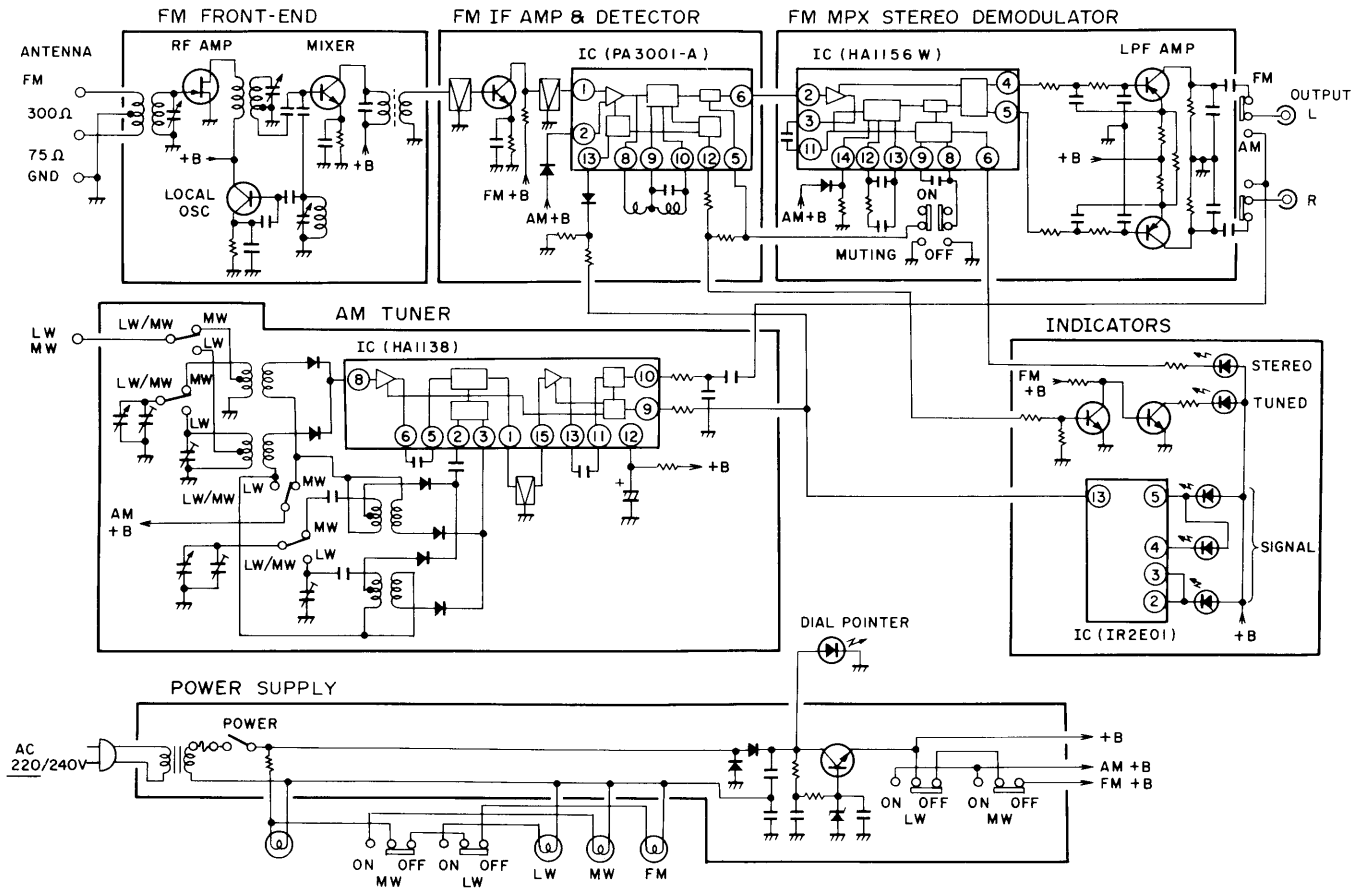

5. CIRCUIT DESCRIPTIONS

FM Tuner

The FM front end is comprised of a J-FET (2SK168) single-stage RF amplifier, and NPN transistor mixer, and an NPN transistor modified Clapp local oscillator.

The IF stage consists of 2 dual-element ceramic filters, a single transistor amplifier element, and IF system IC (PA3001-A) which incorporates the IF limiter amplifier, FM detector, and the FM muting circuit.

FM Multiplex Stereo Decoder

The stereo decoder stage employs an FM MPX IC (HA1156W-P), while the subcarrier signals (frequencies above 19kHz) are removed by an -18dB/oct. active filter consisting of a PNP transistor. This active filter also serves as an amplifier for frequencies within its passband, and eliminates crosstalk.

AM Tuner

The AM tuner is two wave-band tuner with LW (150kHz~350kHz) and MW (525kHz~1605kHz). This employs a 2-ganged tuning capacitor, a single element ceramic filter, and an IC (HA1138) consisting of an RF amplifier, mixer, 2-stage IF amplifier, detector and AGC circuit.

Signal Strength Indicator

The TX-530L signal strength meter is a 3-point LED display meter driven by the meter drive IC (IR2E01).

6. DIAL CORD STRINGING

1. Remove the top cover.
2. Remove the tuning drum from the shaft of the tuning capacitor.
3. Tie one end of the cord to the stud A located inside the tuning drum.
4. Rotate the tuning capacitor right around until the rotor blades are fully intermeshed.
5. Secure the tuning drum back onto the tuning capacitor shaft, making sure that the securing screw faces directly upward.
6. Pass the cord out through the small opening in the circumference of the tuning drum (see diagram), and then take it over pulleys B and C in that sequence.
7. Wind the cord around the tuning shaft 3 times.
8. Pass it over pulley D, wind it around the tuning drum 2 times, and finally tie it to the spring hook F so that it is tensioned.
9. Turn the tuning shaft, and check that the cord moves smoothly.
10. Cut off any excess cord.
11. Turn the tuning shaft counter-clockwise as far as it will go.
12. Align the dial pointer with the starting point of the dial scale, and then pass the cord over it.
13. Check that the dial pointer is in line with the starting point of the dial scale.
14. Finally apply the locking paint to the cord securing positions (stud A and spring hook F) and the dial pointer connection.

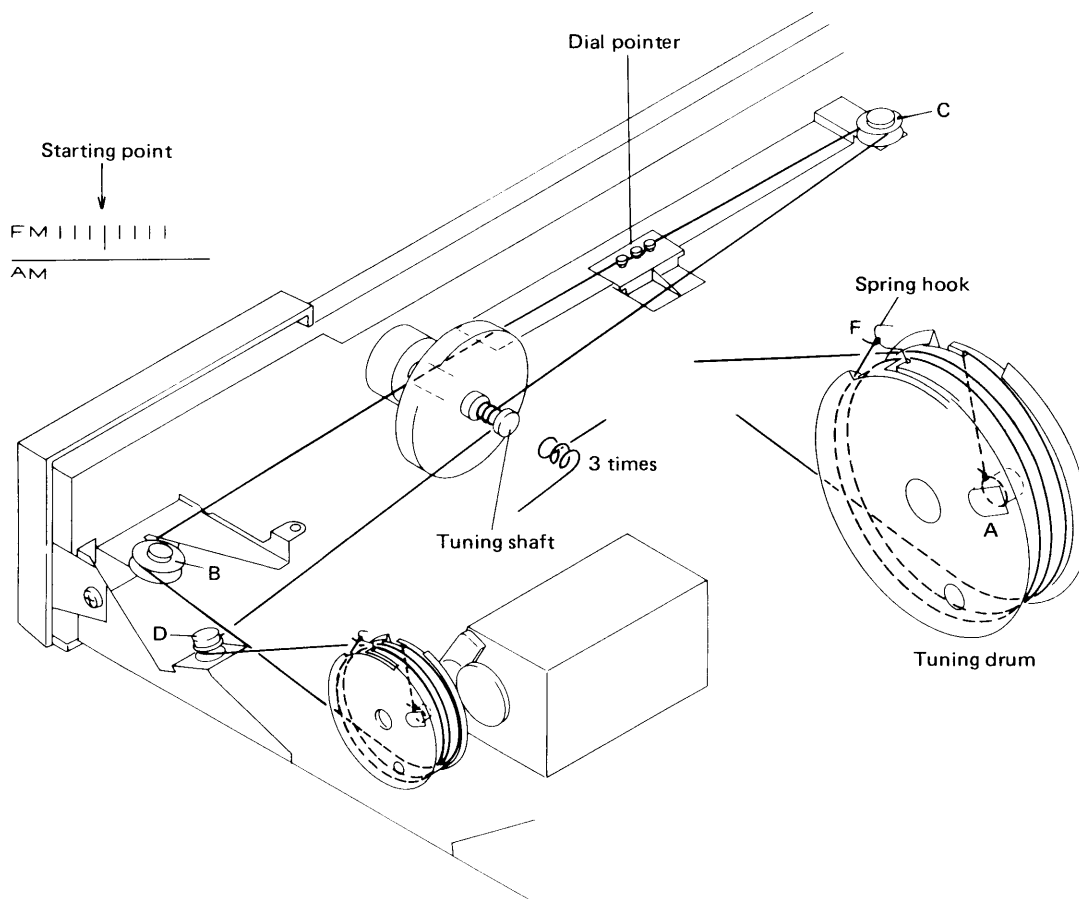

7. P.C. BOARD CONNECTION DIAGRAM

TUNER Ass'y GWE-181

A

B

C

D

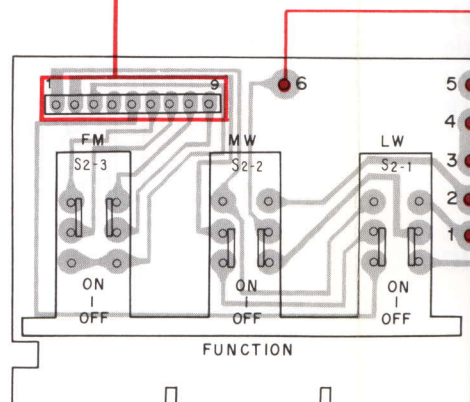
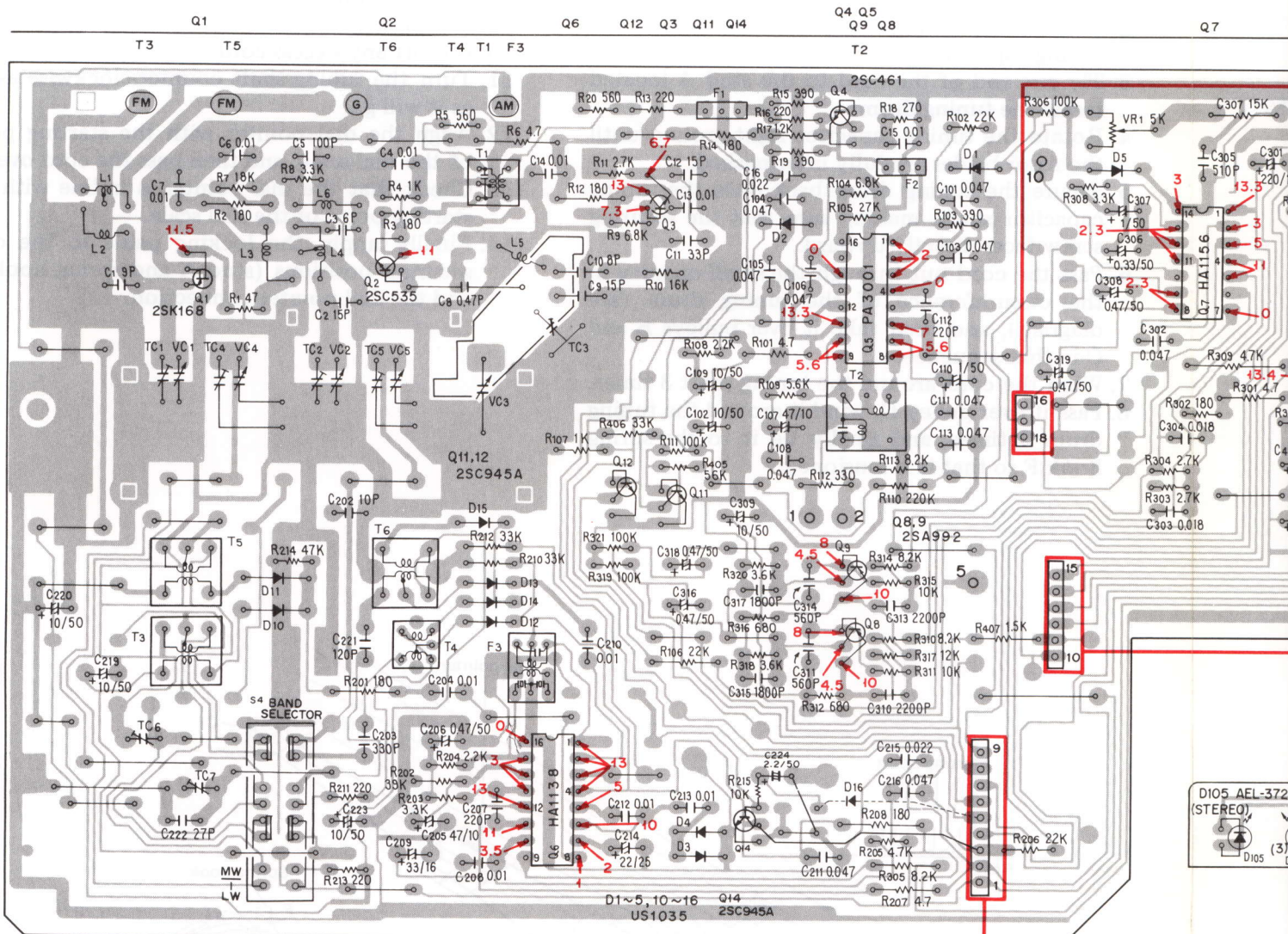

SW1CH Ass'y (C)

Q7 Q13 Q10

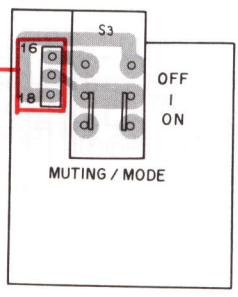
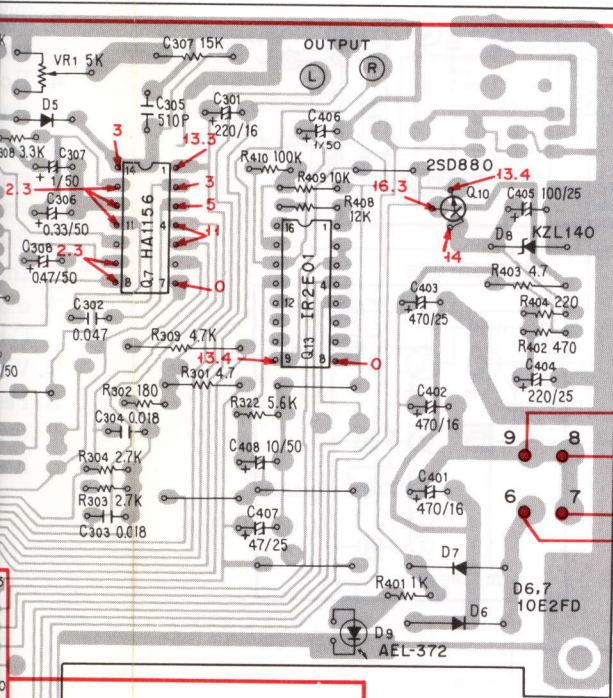

SWITCH Ass'y (B)

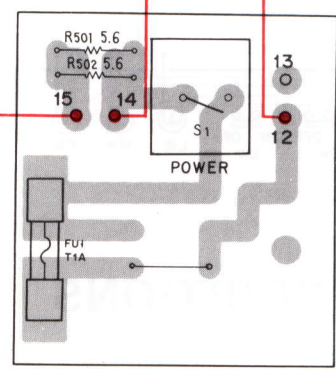
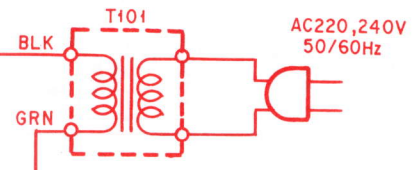

SWITCH Ass'y (A)

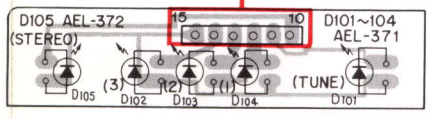

LED Ass'y

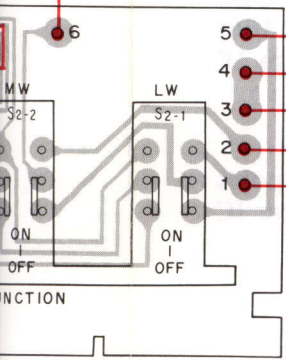

Ass'y (C)



A

B

C

D

8. SCHEMATIC DIAGRAM

A

B

C

D

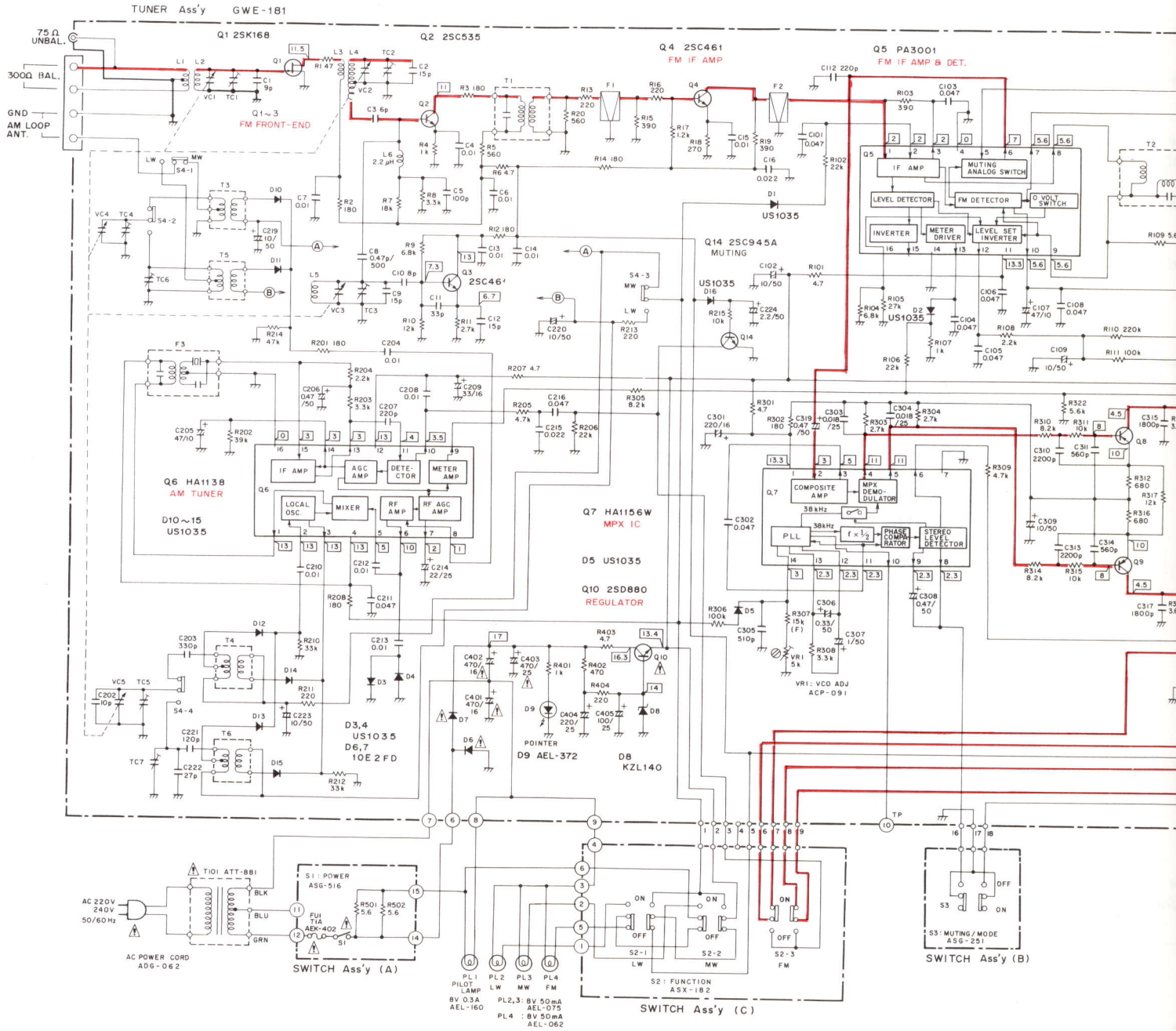

1

2

3

NOTE:

The indicated semiconductors are representative ones only. Other alternative semiconductors may be used and are listed in the parts list.

External Appearance of Transistors and ICs

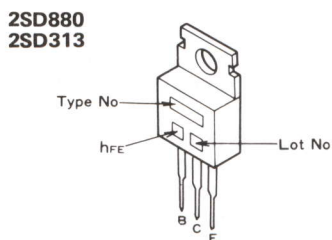
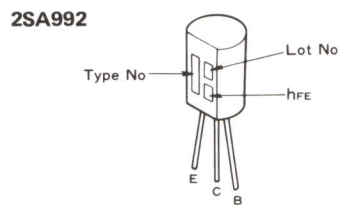
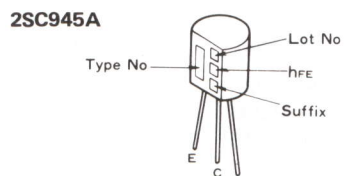
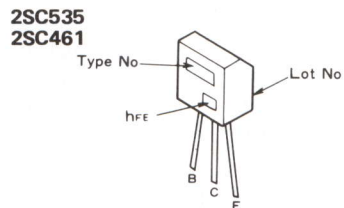
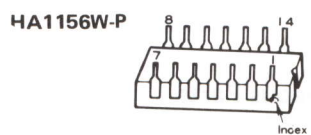
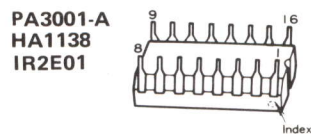
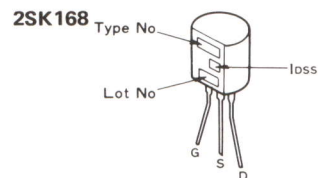

- RESISTORS:**
Indicated in Ω , $\frac{1}{4}W$, $\pm 5\%$ tolerance unless otherwise noted k : k Ω , M : M Ω , (F) : $\pm 1\%$, (G) : $\pm 2\%$, (K) : $\pm 10\%$, (M) : $\pm 20\%$ tolerance
 - CAPACITORS:**
Indicated in capacity (μF)/voltage (V) unless otherwise noted p : pF
Indication without voltage is 50V except electrolytic capacitor.
 - VOLTAGE**
 : DC voltage (V) at no input signal
 : Signal voltage at FM 400Hz 75kHz DEV.
 - OTHERS:**
 : Signal route.
 : Adjusting point.
The mark found on some component parts indicates the importance of the safety factor of the part. Therefore, when replacing, be sure to use parts of identical designation.
- This is the basic schematic diagram, but the actual circuit may vary due to improvements in design.
- SWITCHES:**
S1 : POWER ON — OFF
S2-1 : FUNCTION LW ON — OFF
S2-2 : FUNCTION MW ON — OFF
S2-3 : FUNCTION FM ON — OFF
S3 : MUTING / MODE ON/AUTO — OFF/MONO
S4 : BAND SELECTOR MW — LW
- The underlined indicates the switch position.

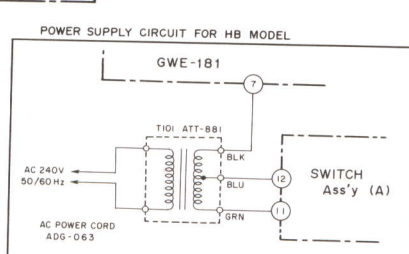
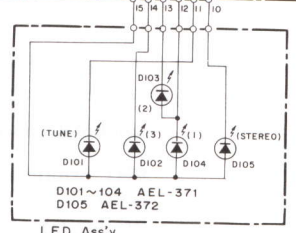
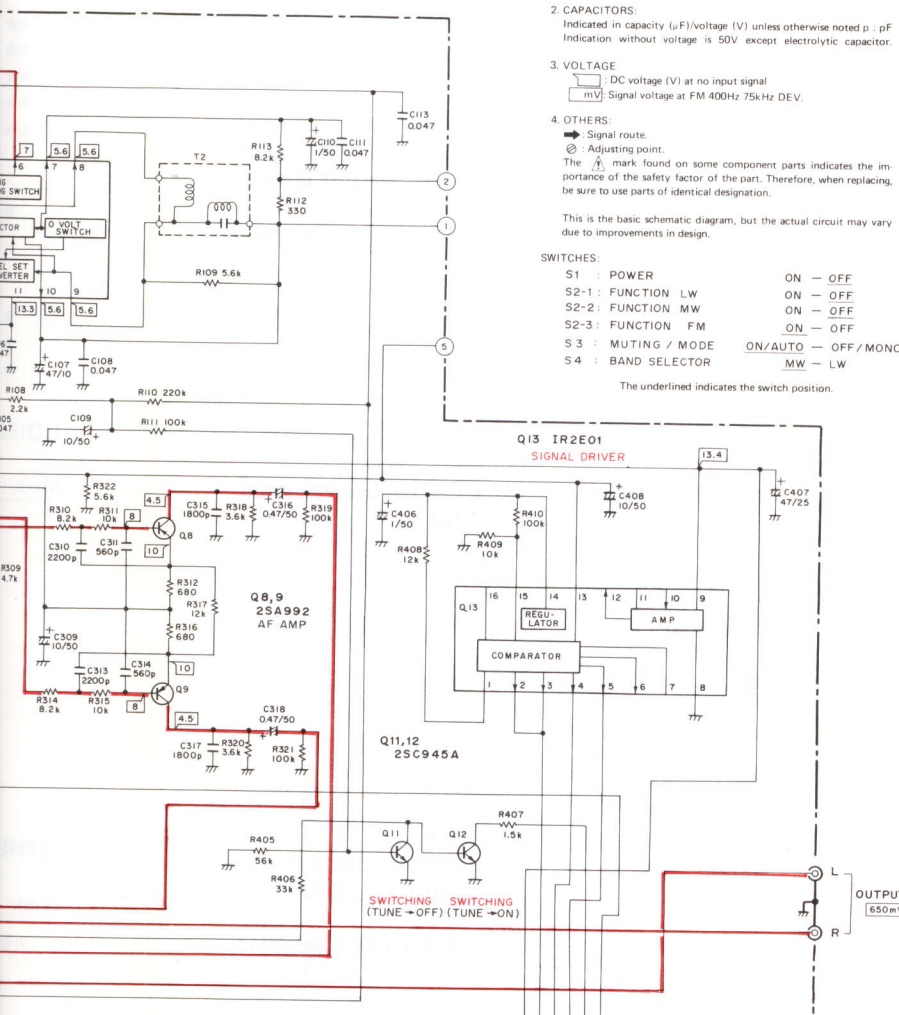

9. ELECTRICAL PARTS LIST

NOTES:

- When ordering resistors, first convert resistance values into code form as shown in the following examples.

Ex. 1 When there are 2 effective digits (any digit apart from 0), such as 560 ohm and 47k ohm (tolerance is shown by J = 5%, and K = 10%).



560Ω	56 × 10 ¹	561	RD¼PS	561J
47kΩ	47 × 10 ³	473	RD¼PS	473J
0.5Ω	0R5		RN2H	0R5K
1Ω	010		RS1P	010K

Ex. 2 When there are 3 effective digits (such as in high precision metal film resistors).

5.62kΩ	562 × 10 ⁰	5621	RN¼SR	5621F
--------	-----------------------	------	-------	-------	-------

- The  mark found on some component parts indicates the importance of the safety factor of the part. Therefore, when replacing, be sure to use parts of identical designation.
- For your Parts Stock Control, the fast moving items are indicated with the marks **★★** and **★**.
★★ GENERALLY MOVES FASTER THAN ★.
This classification shall be adjusted by each distributor because it depends on model number, temperature, humidity, etc.

Miscellaneous Parts

Mark	Part No.	Symbol & Description
	GWE-181	Tuner assembly
 ★	ATT-881	T101 Power transformer
★★	AEL-165	PL1 Lamp assembly
★★	AEL-075	PL2, PL3, PL4 Lamp with wires
 ★★	AEK-402	FU1 Fuse

Tuner Assembly (GWE-181)

CAPACITORS

Mark	Part No.	Symbol & Description
	ACK-027	VC Tuning capacitor
	ACM-006	TC3 Ceramic trimmer
	ACM-015	TC6, TC7 Ceramic trimmer
	CCDUJ 090D 50	C1
	CGB R47K 500	C8
	CCDCH 080D50	C10
	CCDRH 150J 50	C9
	CEA 221M 25L	C404
	CEA 471M 16L	C401, C402
	CEA 471M 25L	C403
	CCDTH 100D 50	C202
	CCDCH 150J 50	C12
	CCDUJ 150J 50	C2
	CCDCH 330J 50	C11
	CCDSH 270J 50	C222
	CCDSL 060D 50	C3
	CCDSL 101J 50	C5
	CCDSL 221J 50	C112, C207
	CQSA 331K 50	C203
	CQSA 511J 50	C305
	CQSA 121K 50	C221
	CEA R33M 50L	C306
	CEA R47M 50L	C206, C308, C316, C318, C319

Mark	Part No.	Symbol & Description
	CEA 010M 50L	C110, C307, C406
	CEA 100M 50L	C102, C109, C220, C309, C408 C219, C223
	CEA 220M 25L	C214
	CEA 330M 16L	C209
	CEA 2R2M 50L	C224
	CEA 470M 10L	C107, C205
	CEA 470M 25L	C407
	CEA 101M 25L	C405
	CEA 221M 16L	C301
	CKDYB 561K 50	C311, C314
	CKDYB 182K 50	C315, C317
	CKDYB 222K 50	C310, C313
	CKDYX 183M 25	C303, C304
	CKDYF 103Z 50	C4, C6, C7, C13, C14, C15, C204, C208, C210, C212, C213
	CKDYF 473Z 50	C101, C103–C106, C108, C111, C113, C216, C302, C211
	CKDYF 223Z 50	C16, C215

Note: When ordering resistors, convert the resistance value into code form, and then rewrite the part no. as before.

Mark	Part No.	Symbol & Description
★	ACP-091	VR1 Semifixed
	RN¼PQ 1502F	R307
	RD¼PM □□□ J	R2, R6, R12, R14, R101, R207 R208, R301, R302, R309, R403
	RD1/8PM □□□ J	R1, R3–R5, R7–R11, R13, R15–R20, R102–R113, R201–R206 R210–R215, R303–R306, R308, R310–R312, R314–R321, R401, R402, R404–R410, R208, R302

SEMICONDUCTORS

Mark	Part No.	Symbol & Description
★★	2SK168	Q1
★★	PA3001-A	Q5
★★	HA1156W-P	Q7
★★	HA1138	Q6
★★	IR2E01	Q13
★★	2SC535	Q2
★★	2SC461	Q3, Q4
★★	2SC945A	Q11, Q12
★★	2SA992	Q8, Q9
⚠★★	2SD880 (2SD313)	Q10
★	US1035 (1S1555) (1S2076) (1S2473)	D1–D5, D10–D15, D16
⚠★	KZL140	D8
★	10E2FD	D6, D7
★	AEL-372	D9

LED Assembly

Mark	Part No.	Symbol & Description
★	AEL-371	D101–D104
★	AEL-372	D105

COILS, FILTERS

Mark	Part No.	Symbol & Description
	ATE-053	T1 FM IF transformer
	ATE-052	T2 FM det. transformer
	ATB-078	T3 AM ANT coil
	ATB-079	T4 AM OSC coil
	ATD-011	T5 LW ANT coil
	ATD-006	T6 LW OSC coil
	ATC-160	L5 OSC coil
	ATH-049	L6 RF choke coil
	ATF-126	F1, F2 FM ceramic filter
	ATF-121	F3 AM ceramic filter

OTHERS

Mark	Part No.	Symbol & Description
★★	ASX-153	Switch
	AKA-018	Terminal 4-P (ANTENNA)
	AKB-077	Pin jack

Switch Assembly A

Mark	Part No.	Symbol & Description
★★	ASG-516 RD4PM5R6J	S1 Push switch (POWER) R501, R502

Switch Assembly B

Mark	Part No.	Symbol & Description
★★	ASG-251	S3 Push switch (FM MUTING)

Switch Assembly C

Mark	Part No.	Symbol & Description
★★	ASX-182	S2 Switch (FUNCTION)

1

2

3

10. EXPLODED VIEW

A

A

B

B

C

C

D

D

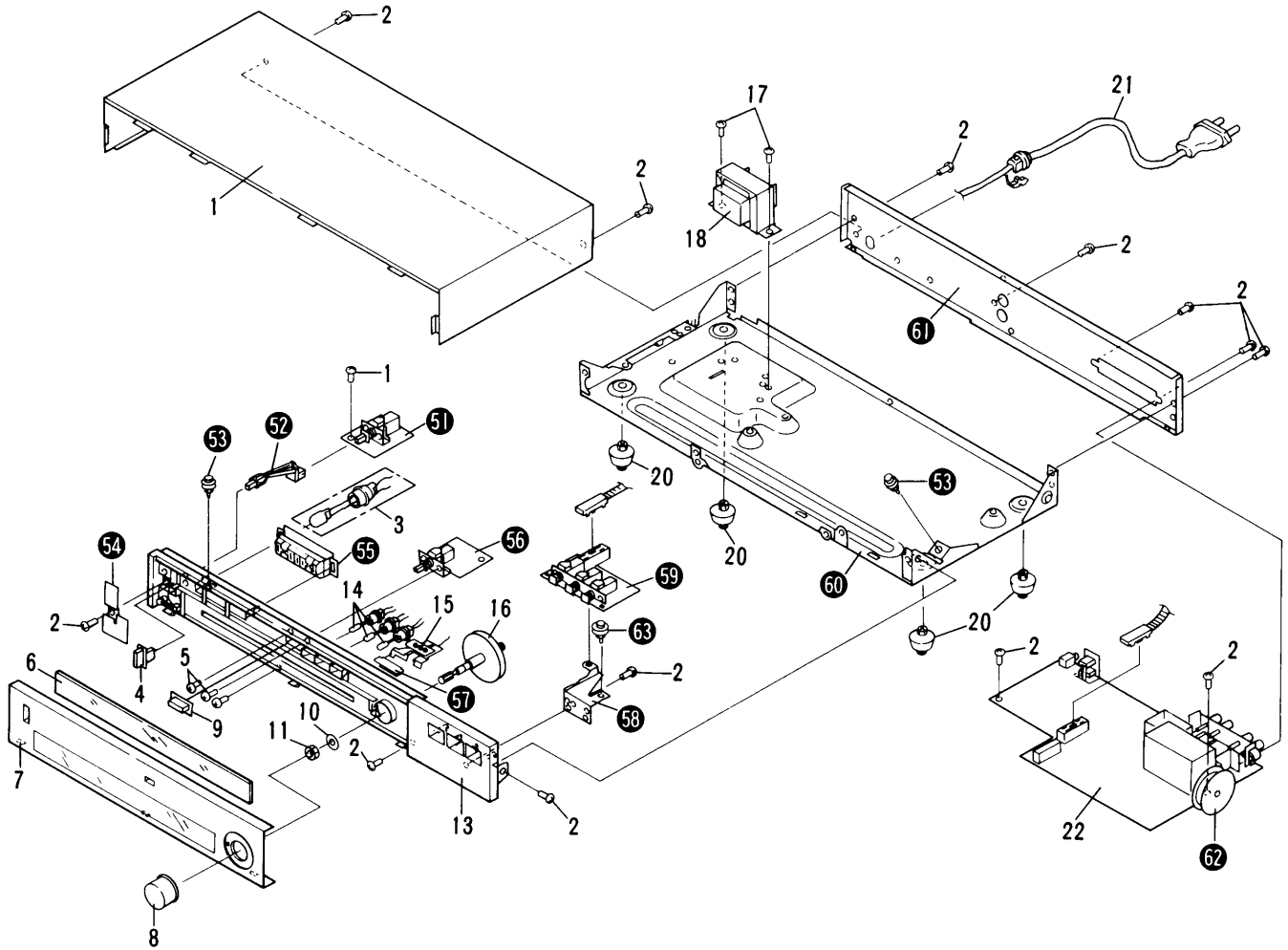

1

2

3

Parts List

NOTES:

- *Parts without part number cannot be supplied.*
 - *The \triangle mark found on some component parts indicates the importance of the safety factor of the part. Therefore, when replacing, be sure to use parts of identical designation.*
 - *For your Parts Stock Control, the fast moving items are indicated with the marks **★★** and **★**.*
 - ***★★** GENERALLY MOVES FASTER THAN **★**.*
- This classification shall be adjusted by each distributor because it depends on model number, temperature, humidity, etc.*

Mark	No.	Part No.	Description	Mark	No.	Part No.	Description
	1.	ANE-357	Top cover		51.		Switch assembly A
	2.	BBZ30P080FZK	Screw		52.		Switch joint
★★	3.	AEL-165	Lamp assembly		53.		Pulley assembly
	4.	AAD-417	Push knob A (POWER)		54.		Plate
	5.	PMZ30P060FMC	Screw		55.		LED assembly
	6.	AAG-237	Dial scale		56.		Switch assembly B
	7.	ANM-128	Front panel		57.		Smoother
	8.	AAA-079	Knob (TUNING)		58.		Pulley holder
	9.	AAD-480	Push knob B (FM MUTING)		59.		Switch assembly C
	10.	WA73F118U050	Washer		60.		Bottom plate
	11.	ABN-067	Nut M7		61.		Rear panel
	12.		62.		Tuning drum
★★	13.	ANR-519	Panel stay assembly		63.		Pulley assembly
	14.	AEL-075	Lamp with wires				
	15.	AAF-117	Dial pointer assembly				
	16.	AXA-350	Tuning shaft assembly				
	17.	ABA-252	Screw				
\triangle ★	18.	ATT-881	Power transformer				
	19.				
	20.	AEC-784	Foot assembly				
\triangle	21.	ADG-062	AC power cord (HE)				
\triangle		ADG-063	AC power cord (HB)				
	22.	GWE-181	Tuner assembly				

11. PACKING

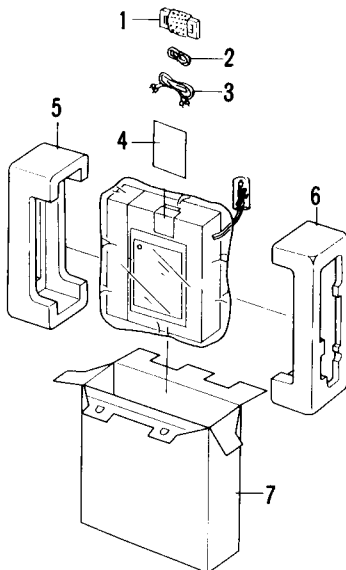

Parts List

Mark	No.	Part No.	Description
	1.	ATB-076	ANT assembly
	2.	ADH-004	T-type FM antenna
	3.	ADE-015	Cord
	4.	ARE-023	Operating instructions (HE) (English/German/French/Italian)
		ARB-485	Operating instructions (HB) (English)
	5.	AHA-296	Front pad
	6.	AHA-297	Rear pad
	7.	AHE-013	Packing case

12. ADJUSTMENTS

FM Tuner Section

- Check that the dial pointer indicates a starting point.
- Connect the SIGNAL meter between terminal no. 5 of tuner ass'y and the ground.
- Connect the TUNING meter between terminals no. 1 and no. 2 of tuner ass'y.
- Set the FM switch to ON and the FM MUTING switch to OFF.

Step	FM SG (400Hz, ± 75 kHz deviation)		Position of dial pointer	Adjustment point	Adjustment procedure
	Frequency	Level			
1	106MHz	106dB	106MHz	TC3	Set the TUNING meter to the center position and the SIGNAL meter to the maximum value.
2	90MHz	106dB	90MHz	VC3 (Fig. 12-1)	
3	Repeat steps 1 to 2.				
4	98MHz	18dB	98MHz	TC1 TC2, T1	Set the SIGNAL meter to the maximum value.
5	No signal		White noise	T2	Set the TUNING meter to the center position.
6	Turn ON the FM MUTING switch.				
7	98MHz	25~35dB Variable	98MHz	R104	Remove R104 when muting operation stops above 30dB.
8	98MHz	86dB Not modulated	98MHz	VR1	Set the signal of the terminal no. 10 to 19kHz (± 100 Hz).
9	98MHz	86dB Stereo modulation	98MHz	T1 (within $\pm 90^\circ$)	Minimize the distortion of the OUTPUT terminal signal.

NOTE:

Connect the MPX SG to the FM SG external modulator terminal and set the modulation to Main (1kHz, L+R) ± 67.5 kHz deviation, Pilot (19kHz) ± 7.5 kHz deviation.

AM Tuner Section

- Check that the dial pointer indicates a starting point.
- Turn ON the MW switch.
- Connect the SIGNAL meter between the terminal no. 5 of tuner ass'y and the ground.

Step	AM SG (400Hz, 30% modulation)		Position of dial pointer	Adjustment point	Adjustment procedure	
	Frequency	Level				
1	1400kHz	100dB	1400kHz	TC5	Set the output of the OUTPUT terminal to the maximum value.	
2	600kHz	100dB	600kHz	T4		
3	Repeat steps 1 to 2.					
4	1400kHz	30dB	1400kHz	TC4		
5	600kHz	30dB	600kHz	T3		
6	Repeat steps 4 to 5.					

Long Wave Section

- Set the AM BAND switch to the LW position.

Step	AM SG (400Hz, 30% modulation)		Position of dial pointer	Adjustment point	Adjustment procedure
	Frequency	Level			
1	340kHz	100dB	340kHz	TC6	Adjust until demodulated signal at OUTPUT terminal is maximum.
2	160kHz	100dB	160kHz	T5	
3	Set the AM SG to 30dB output level, repeat steps 1 to 2 above.				
4	340kHz	50dB	340kHz	TC7	Adjust until demodulated signal at OUTPUT terminal is maximum.
5	160kHz	50dB	160kHz	T6	
6	Repeat steps 4 to 5 until maximum sensitivity is attained.				

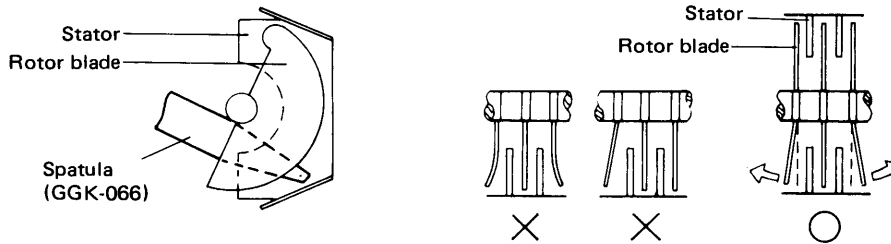

Fig. 12-1 Adjustment of tuning capacitor

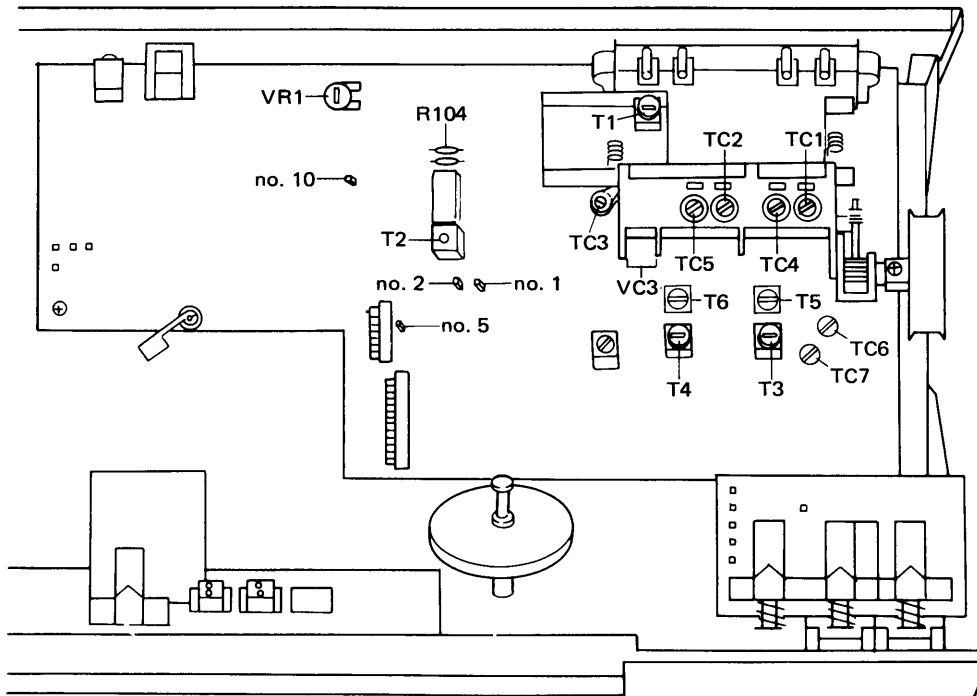

Fig. 12-2 Adjustment points

12. RÉGLAGE

Section tuner FM

- Vérifier que l'aiguille se trouve sur la position de départ.
- Brancher le S-mètre (SIGNAL) entre la borne n° 5 du tuner et la masse.
- Brancher l'indicateur d'accord (TUNING) entre la borne n° 1 et la borne n° 2 du tuner.
- Déplacer l'interrupteur FM sur la position ON, et le sélecteur de réglage silencieux FM (FM MUTING) sur la position OFF.

Etape	FM SG (400Hz, déviation ±75kHz)		Position de l'aiguille	Point de réglage	Procédure de réglage
	Fréquence	Niveau			
1	106MHz	106dB	106MHz	TC3	Déplacer l'indicateur d'accord sur la position centrale et régler le S-mètre (SIGNAL) à sa valeur maximum.
2	90MHz	106dB	90MHz	VC3 (Fig. 12-1)	
3	Répéter les étapes 1 et 2.				
4	98MHz	18dB	98MHz	TC1 TC2, T1	Régler le S-mètre (SIGNAL) à sa valeur maximum.
5	Pas de signal		Bruit blanc	T2	Déplacer l'indicateur d'accord sur la position centrale.
6	Déplacer le sélecteur de réglage silencieux FM (FM MUTING) sur la position ON.				
7	98MHz	25~35dB Variable	98MHz	R104	Enlever le R104 lorsque le réglage silencieux atteint 30dB.
8	98MHz N'est pas modulé	86dB	98MHz	VR1	Régler le signal de la borne n° 10 à 19kHz (±100Hz).
9	98MHz Modulation stéréo	86dB	98MHz	T1 (entre ±90°)	Régler au minimum la distortion du signal de la borne de sortie (OUTPUT).

NOTE:

Connecter le MPX SG à la borne du modulateur extérieur FM SG et régler la modulation Main (principale) sur une déviation de (1kHz, L+R) ±7,5kHz.

Section tuner AM

- Vérifier que l'aiguille se trouve sur la position de départ.
- Déplacer l'interrupteur MW sur la position ON.
- Brancher le S-mètre (SIGNAL) entre la borne n° 5 du tuner et la masse.

Etape	AM SG (400Hz, modulation de 30%)		Position de l'aiguille	Point de réglage	Procédure de réglage	
	Fréquence	Niveau				
1	1400kHz	100dB	1400kHz	TC5	Régler la sortie de la borne de sortie (OUTPUT) à sa valeur maximum.	
2	600kHz	100dB	600kHz	T4		
3	Répéter les étapes 1 et 2.					
4	1400kHz	30dB	1400kHz	TC4		
5	600kHz	30dB	600kHz	T3		
6	Répéter les étapes 4 et 5.					

Section grandes ondes

- Déplacer le sélecteur de gammes d'ondes sur la position LW (grandes ondes).

Etape	AM SG (400Hz, modulation de 30%)		Position de l'aiguille	Point de réglage	Procédure de réglage
	Fréquence	Niveau			
1	340kHz	100dB	340kHz	TC6	Régler jusqu'à ce que le signal de démodulation à la borne de sortie (OUTPUT) soit au maximum.
2	160kHz	100dB	160kHz	T5	
3	Régler le signal AM (AM SG) à un niveau de sortie de 30dB, puis, répéter les étapes 1 et 2 ci-dessus.				
4	160kHz	50dB	160kHz	TC7	Régler jusqu'à ce que le signal démodulé à la borne de sortie (OUTPUT) soit au maximum.
5	160kHz	50dB	160kHz	T6	
6	Répéter les étapes 4 et 5 jusqu'au point d'intensité maximum.				

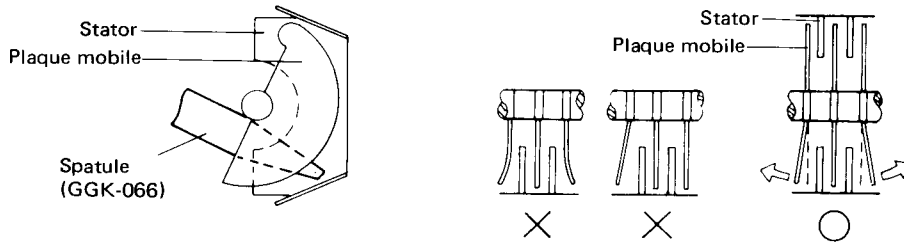

Fig. 12-1 Réglage du condensateur de syntonisation

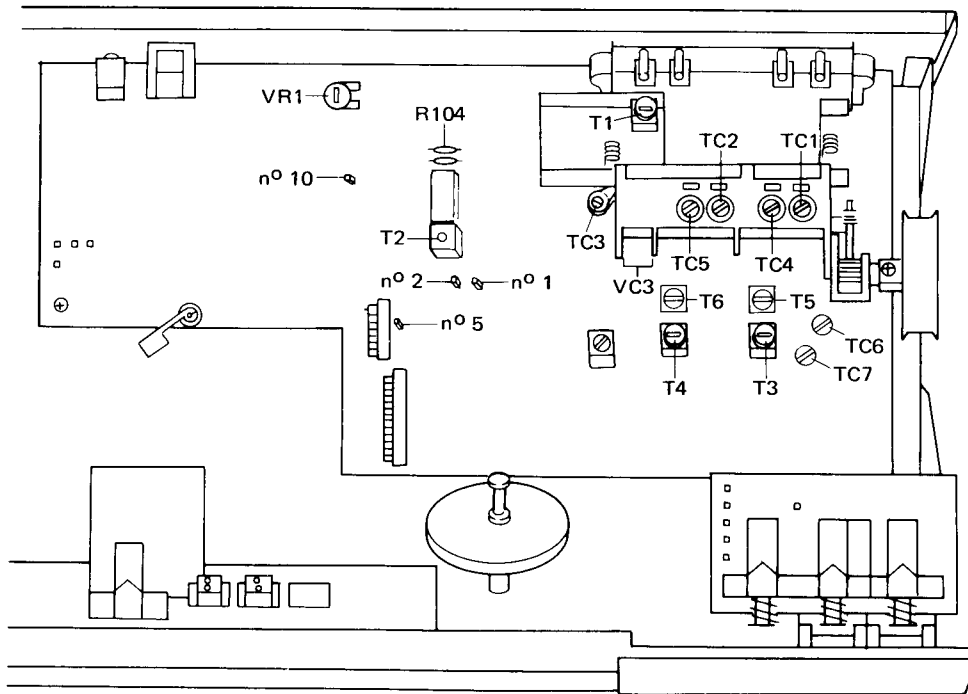

Fig. 12-2 Points de réglage

12. AJUSTE

Sección del sintonizador de FM

- Comprobar que el indicador del cuadrante señala un punto de inicio.
- Conectar el medidor de señal (SIGNAL) entre el terminal no. 5 del conjunto del sintonizador y tierra.
- Conectar el medidor de sintonización (TUNING) entre los terminales no. 1 y 2 del conjunto del sintonizador.
- Poner el selector de FM en la posición ON y el interruptor de silenciamiento en FM (FM MUTING) en la posición OFF.

Paso	FM SG (400Hz, ± 75 kHz de desviación)		Posición del indicador del cuadrante	Punto de ajuste	Procedimiento de ajuste
	Frecuencia	Nivel			
1	106MHz	106dB	106MHz	TC3	Poner el medidor de sintonización (TUNING) en la posición central y el medidor de señal (SIGNAL) en el valor máximo.
2	90MHz	106dB	90MHz	VC3 (Fig. 12-1)	
3	Repetir los pasos 1 al 2.				
4	98MHz	18dB	98MHz	TC1, TC2, T1	Ajustar el medidor de señal (SIGNAL) al valor máximo.
5	No hay señal		Ruido blanco	T2	Poner el medidor de sintonización (TUNING) en la posición central.
6	Poner en la posición ON el interruptor de silenciamiento en FM (FM MUTING).				
7	98MHz	25~35dB Variable	98MHz	R104	Extraer el R104 cuando la operación de silenciamiento se detiene por encima de los 30dB.
8	98MHz no modulada	86dB	98MHz	VR1	Ajustar la señal del terminal no. 10 a 19kHz (± 100 Hz).
9	98MHz Modulación estereofónica	86dB	98MHz	T1 (dentro de $\pm 90^\circ$)	Minimizar la distorsión de la señal del terminal de salida (OUTPUT).

NOTA:

Conectar el generador de señal de multiplex (MPX SG) al terminal de modulador exterior del generador de señal de FM (FM SG) y ajustar la modulación a Principal (1kHz, Izq. \pm Der.) $\pm 67,5$ kHz de desviación.

Sección del sintonizador de AM

- Comprobar que el indicador del cuadrante señale un punto de inicio.
- Poner en la posición ON el selector de MW.
- Conectar el medidor de señal (SIGNAL) entre el terminal no. 5 del conjunto del sintonizador y tierra.

Paso	AM SG (400Hz, 30% de modulación)		Posición del indicador del cuadrante	Punto de ajuste	Procedimiento de ajuste	
	Frecuencia	Nivel				
1	1400kHz	100dB	1400kHz	TC5	Ajustar la salida del terminal de salida (OUTPUT) al valor máximo.	
2	600kHz	100dB	600kHz	T4		
3	Repetir los pasos 1 y 2.					
4	1400kHz	30dB	1400kHz	TC4		
5	600kHz	30dB	600kHz	T3		
6	Repetir los pasos 4 y 5.					

Sección de onda larga

- Poner el selector de banda de AM (AM BAND) en la posición LW.

Paso	AM SG (400Hz, 30% de modulación)		Posición del indicador del cuadrante	Punto de ajuste	Procedimiento de ajuste
	Frecuencia	Nivel			
1	340kHz	100dB	340kHz	TC6	Ajustar hasta que la señal demodulada en el terminal de salida (OUTPUT) sea la máxima.
2	160kHz	100dB	160kHz	T5	
3	Ajustar el generador de señales de AM (AM SG) al nivel de salida de 30dB, y repetir los pasos 1 y 2 de arriba.				
4	340kHz	50dB	340kHz	TC7	Ajustar hasta que la señal demodulada en el terminal de salida (OUTPUT) sea la máxima.
5	160kHz	50dB	160kHz	T6	
6	Repetir los pasos 4 y 5 hasta que se logre la máxima sensibilidad.				

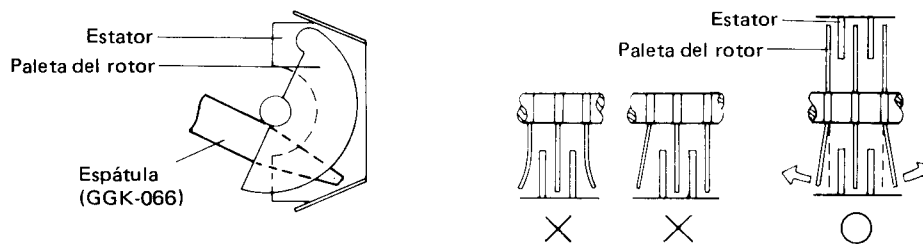

Fig. 12-1 Ajuste del capacitor de sintonización

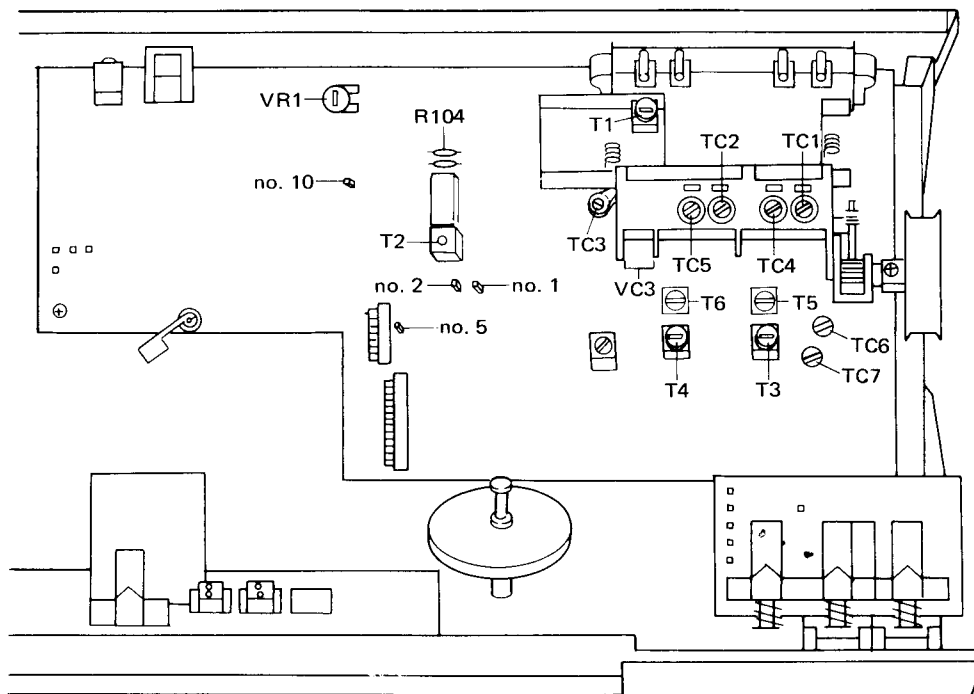

Fig. 12-2 Puntos de ajuste